

**APLICAÇÃO**

Os passa-cabos são proteções para passagem de cabos entre a porta e seu batente, evitando que os mesmos fiquem expostos e sujeito a danos ou corte intencional.

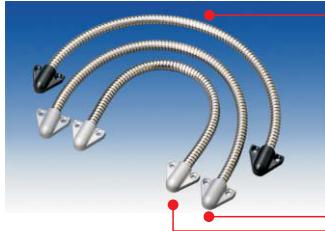

DL-200-40  
DL-200P-40 (sob encomenda)  
DL-200A-30 (sob encomenda)  
Comprimento: 40 cm  
Luva plástica triangular  
Montagem de superfície

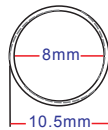

DL-350  
Comprimento: 40 cm  
Luva de alumínio quadrada  
Montagem de superfície

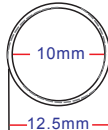

DL-400  
Comprimento: 29 cm  
Montagem de embutir

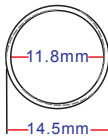

DL-500  
Comprimento: 29 cm  
Tubo flexível em inox  
Montagem de embutir  
Caixa de montagem oval  
patenteada, fácil de instalar

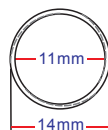

**DIMENSÕES**

DL-200P

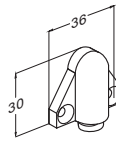

DL-350

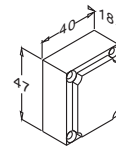

DL-400

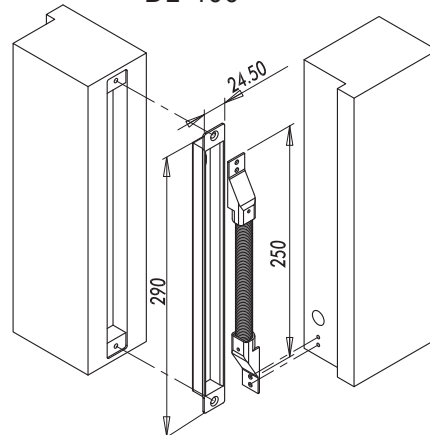

DL-500

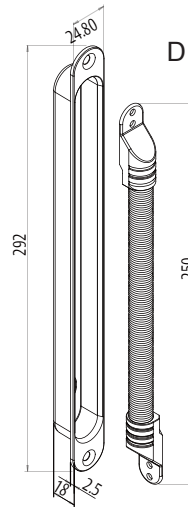

Unidade: mm

**EXEMPLO DE INSTALAÇÃO**



BRASIL  
+55 11 5693 -4450

MÉXICO  
+52 5541622021

LIGAÇÃO GRATUITA  
+01-0600-212-0584

SEDE VAULT  
Rua Augusto Ferreira de Moraes, 618 - Socorro,  
São Paulo - SP, Brasil, CEP: 04763-001

EMAIL  
sales@vaultbr.com

WEBSITE  
www.vaultbr.com

**VAULT**  
ASSA ABLOY

Copyright VAULT© All Rights Reserved  
DL-200/350/400/500. Ver. A Publish: 2013.01.10